

Matchmaking
18 sept. 2020



Optomechanics group
Aurélien Dantan

SiN trampolines



TEM window
(Norcada, 30\$)

- area \sim mm², thickness \sim 50-100 nm, m \sim ng
 - $R \sim$ 10-35%, ultralow absorption
 - high tensile stress (GPa)
- square drum modes \sim MHz, $Q \sim 10^6$ (*)

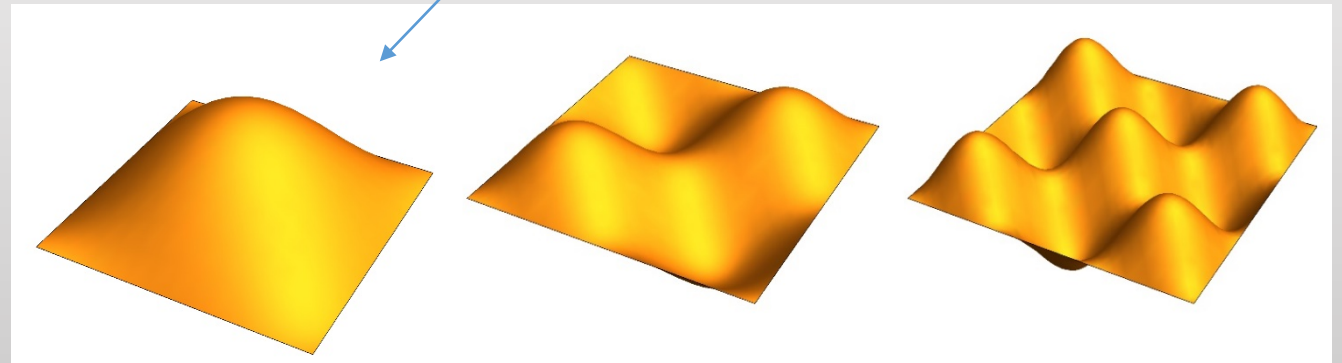
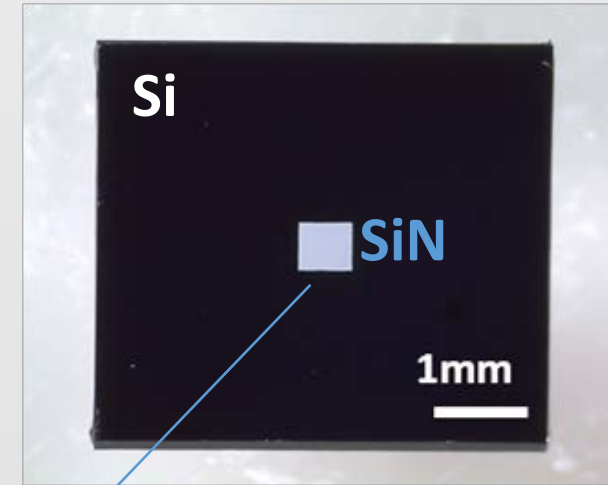

(*)Probably the best (commercial) trampolines in the world



Vibrations: optical interferometry

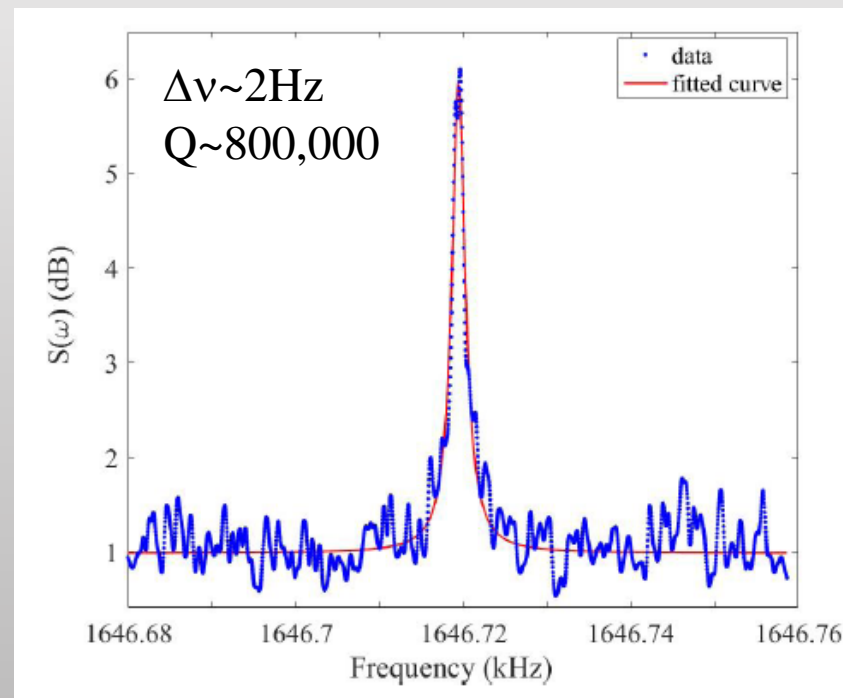
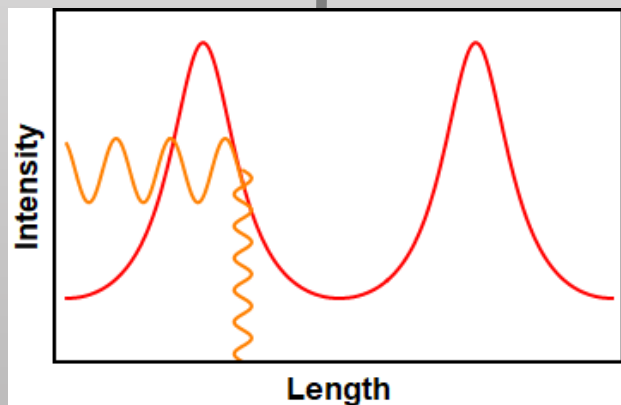
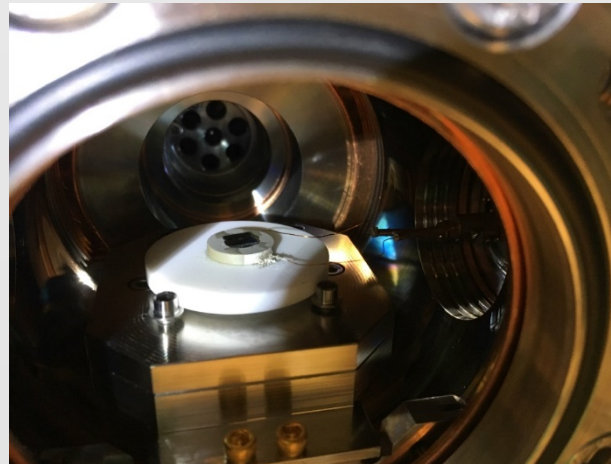
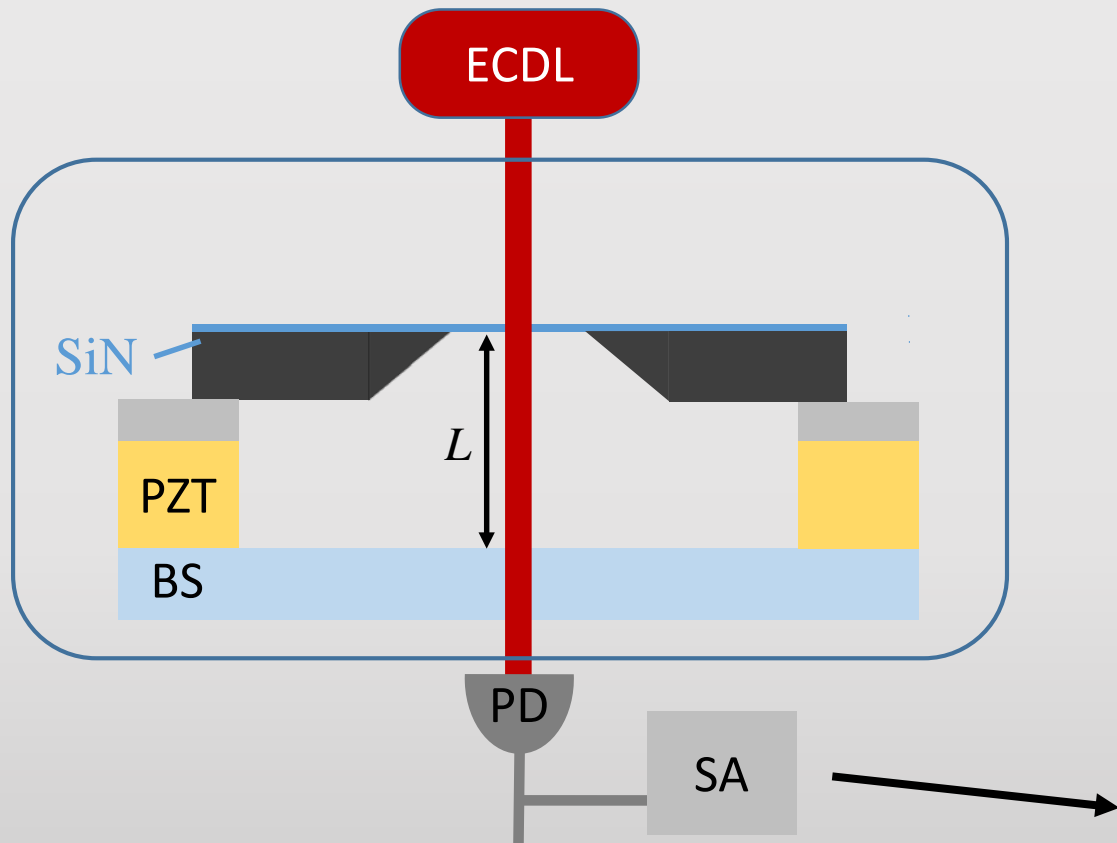

Electro-opto-mechanical arrays

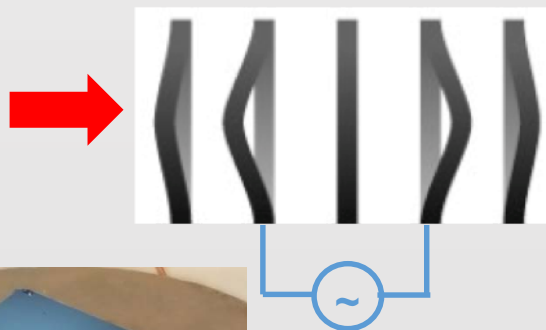

Few-photon optomechanics

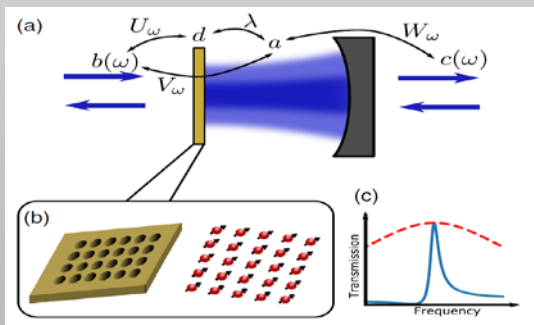
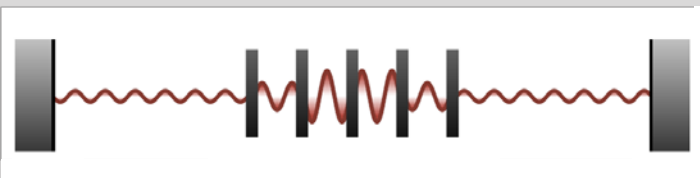

Optomechanical sensors

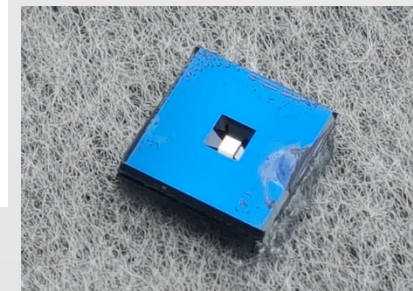
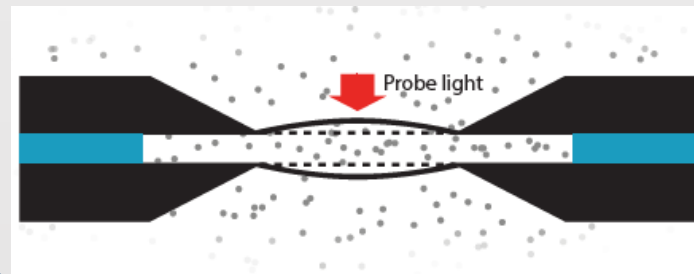

Multimode
OM

Quantum
OM

Hybrid
OM

Photonics

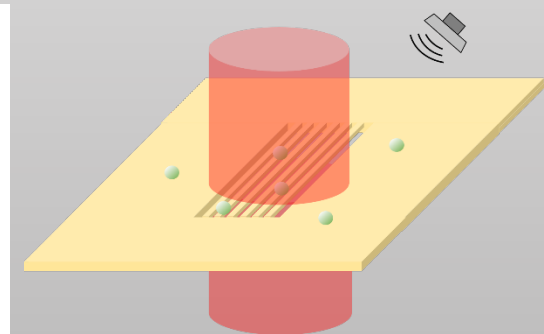
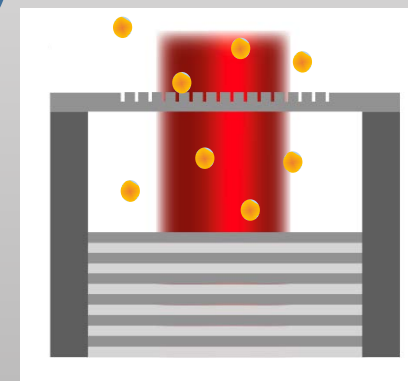
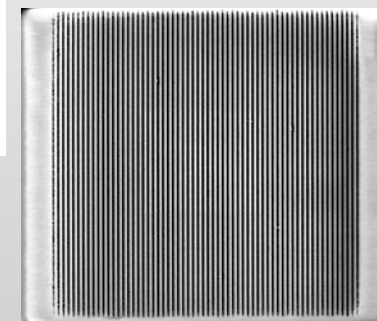
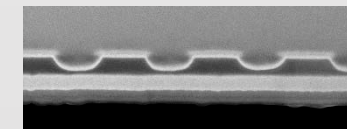
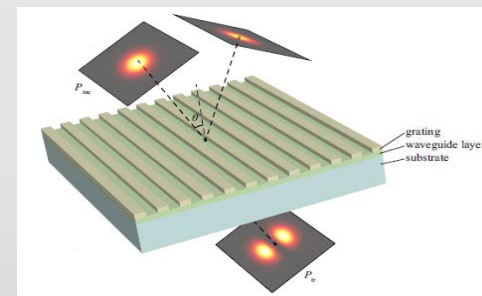

Hybrid cavities

Trampoline sandwiches

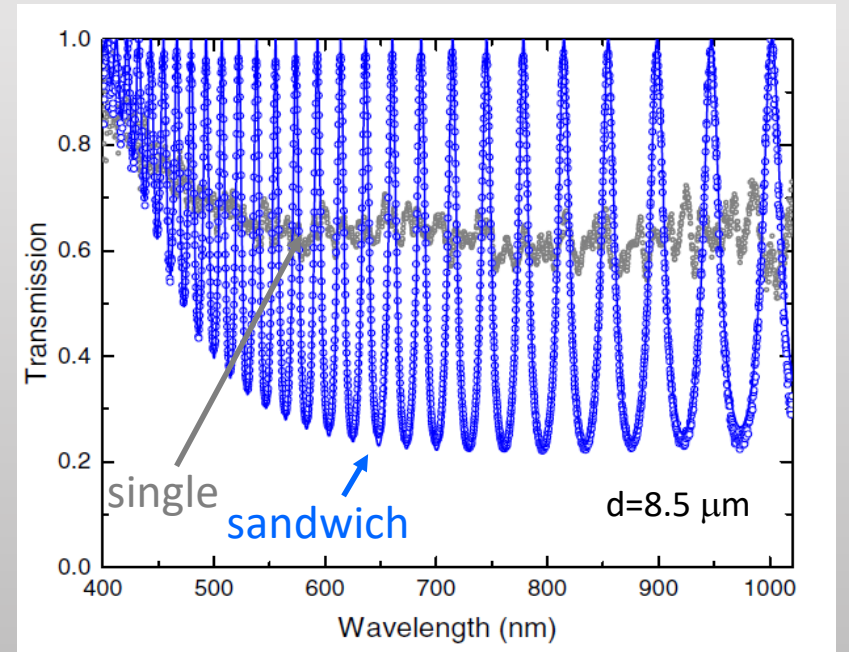
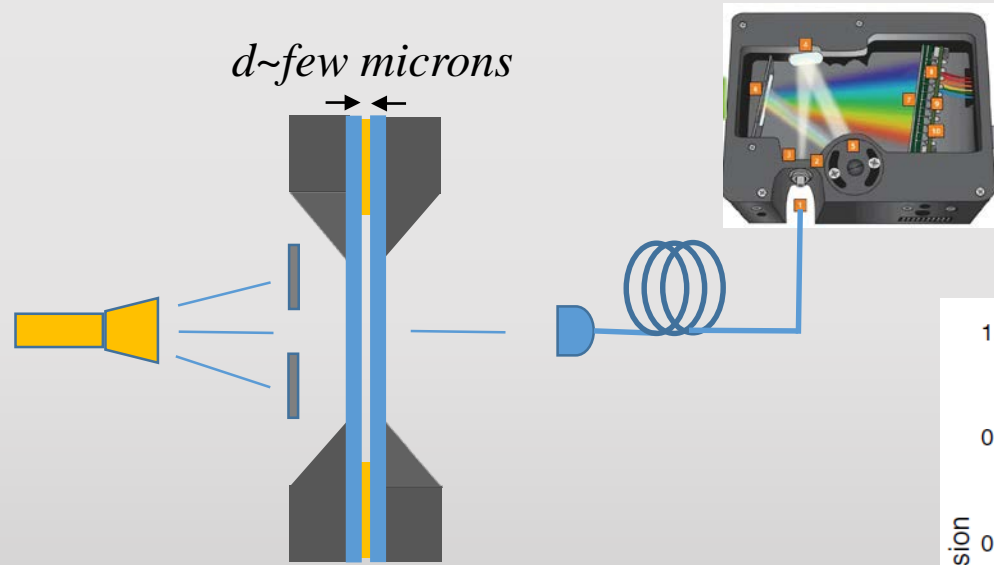
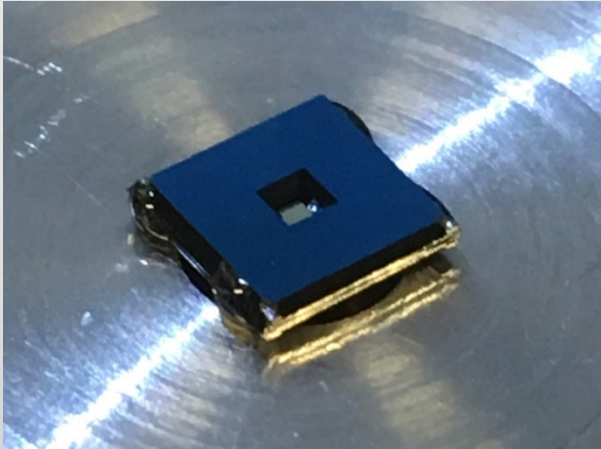

Trampoline sandwiches

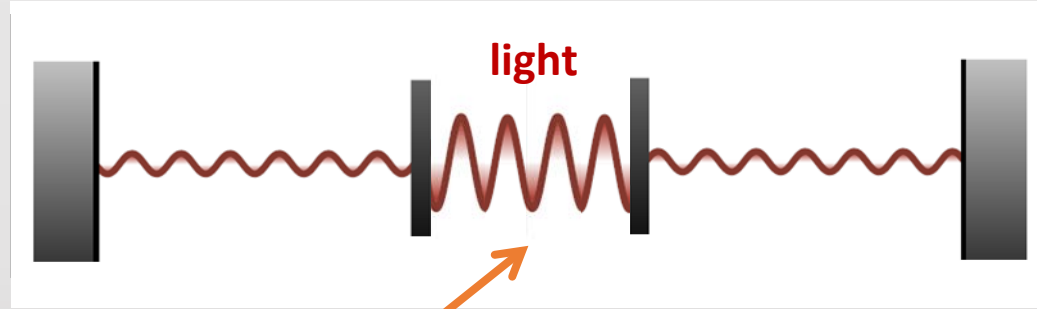
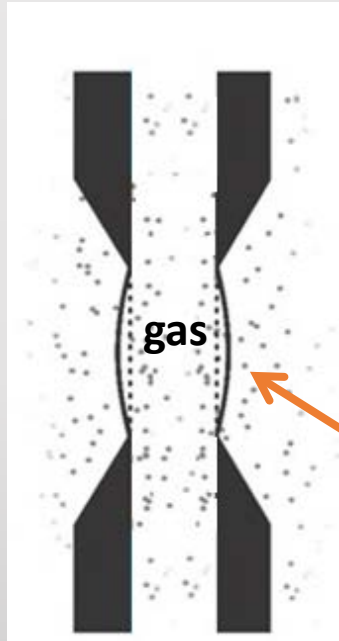

*Enhanced
pressure
effects*

Squeeze film pressure sensors

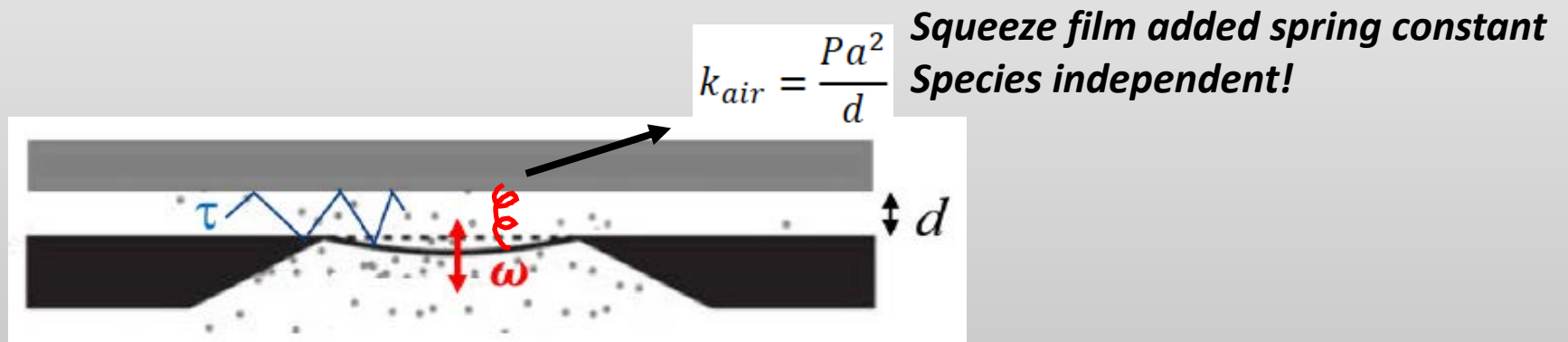
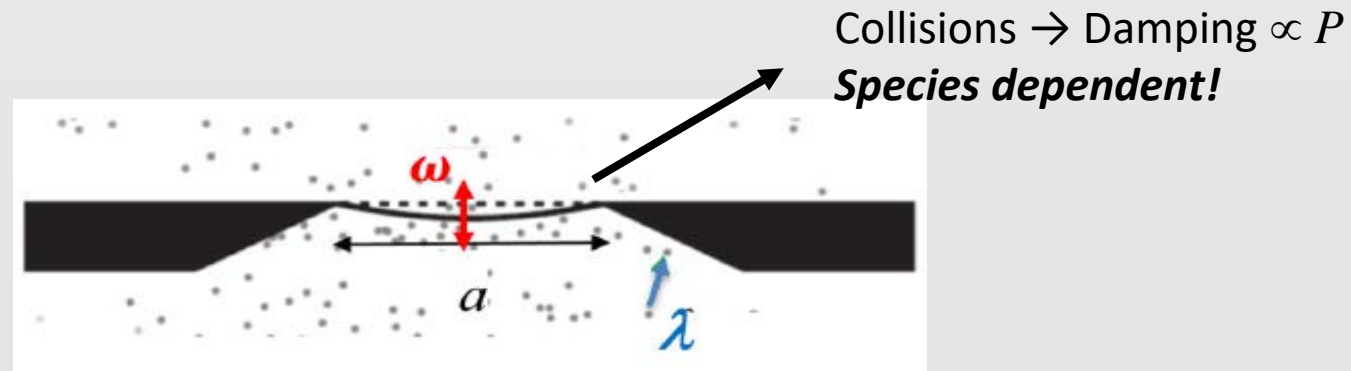

Squeeze film pressure sensors

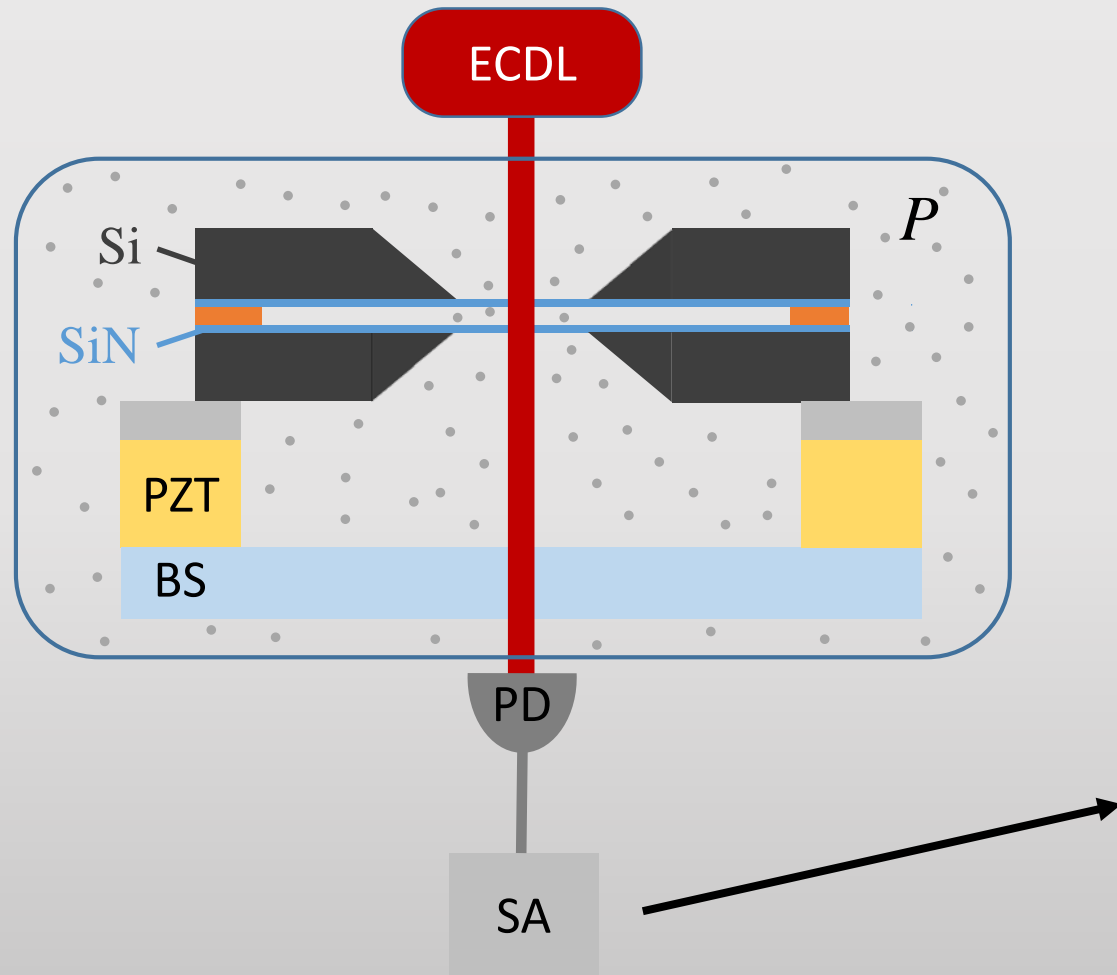

$d \sim 2-3 \mu\text{m}$

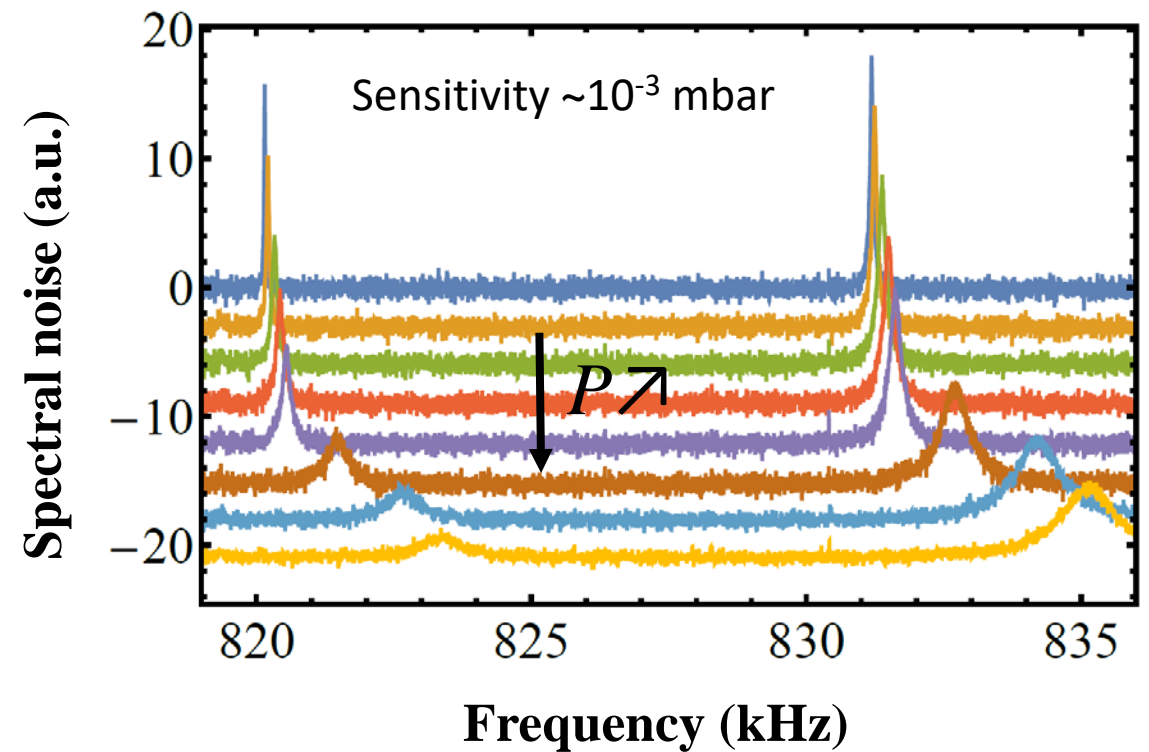
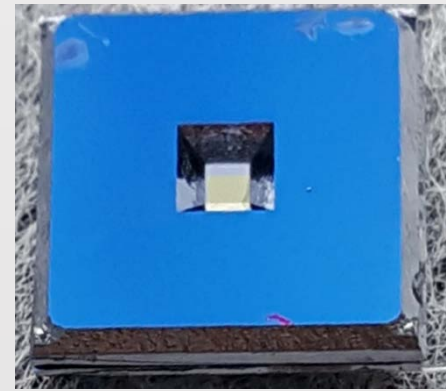

ASVAP: absolute damptryk målinger



Henrik Pedersen



Merete Bilde
(Kemi)

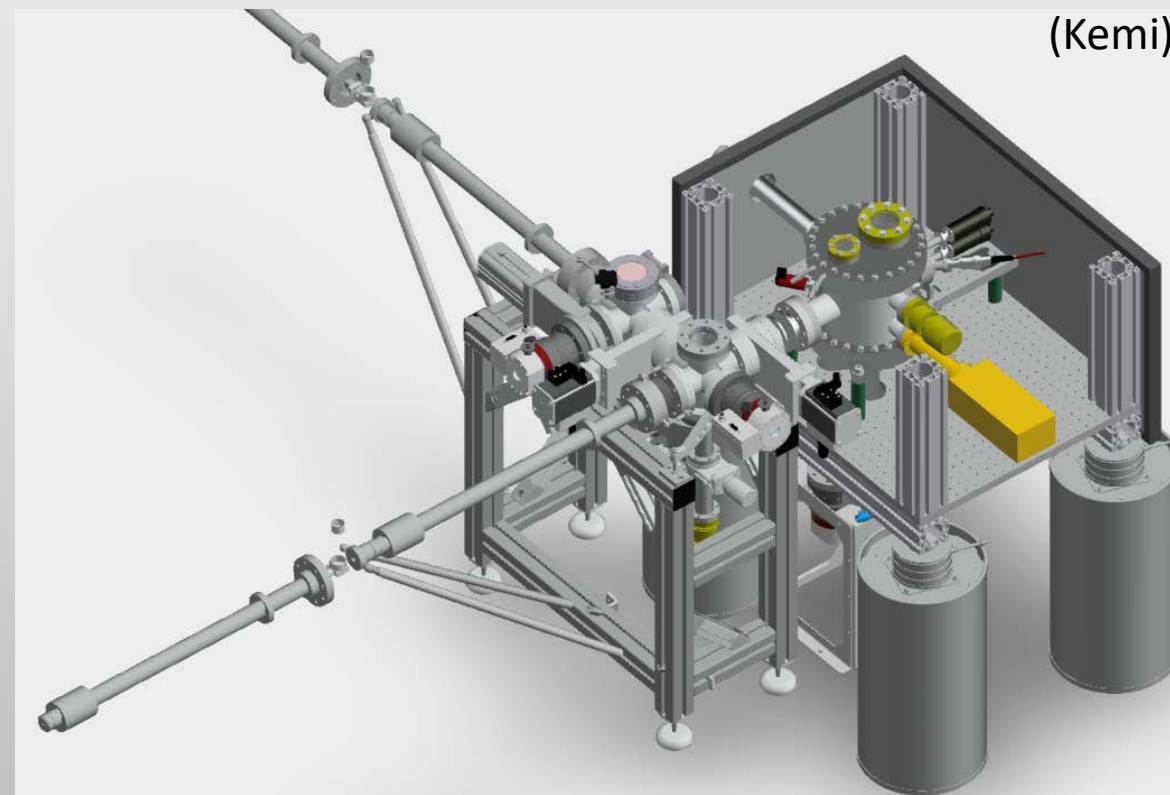
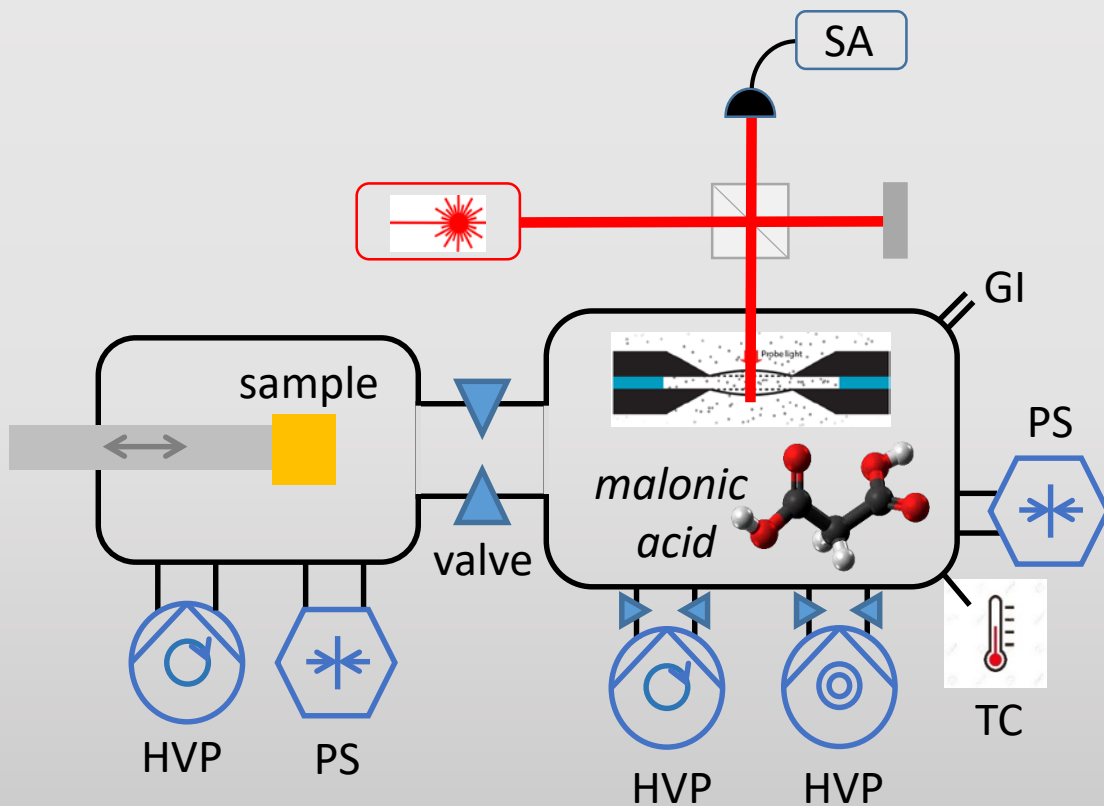

SiN trampolines



TEM window
(Norcada, 30\$)

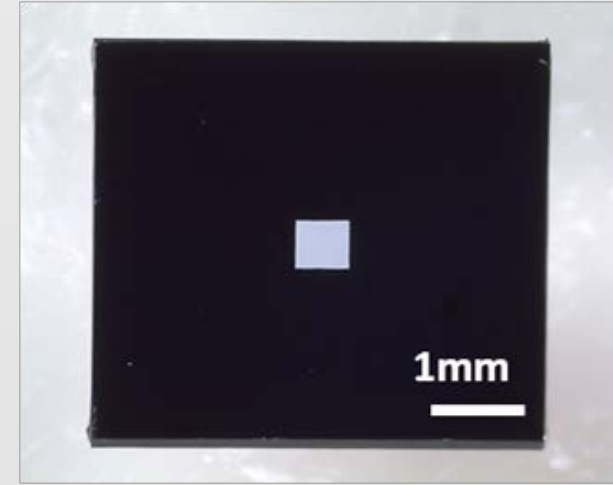

- area $\sim \text{mm}^2$, thickness $\sim 50\text{-}100 \text{ nm}$, $m \sim \text{ng}$
 - $R \sim 10\text{-}35\%$, ultralow absorption
 - high tensile stress (GPa)
- square drum modes $\sim \text{MHz}$, $Q \sim 10^6$ (*)

Higher reflectivity?

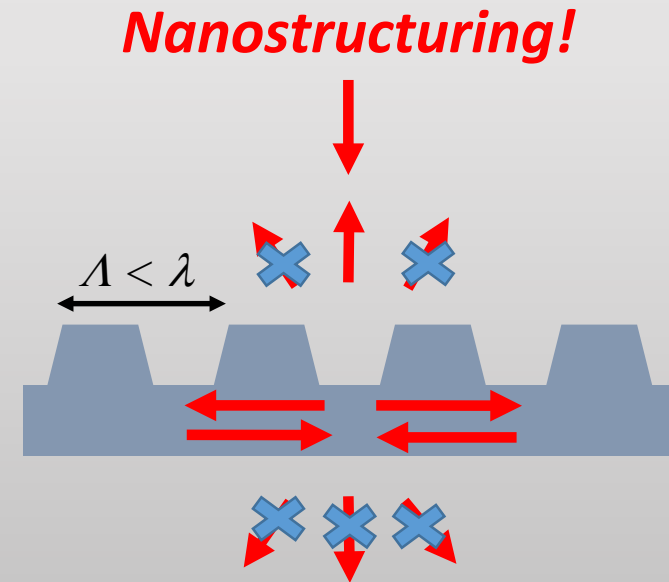
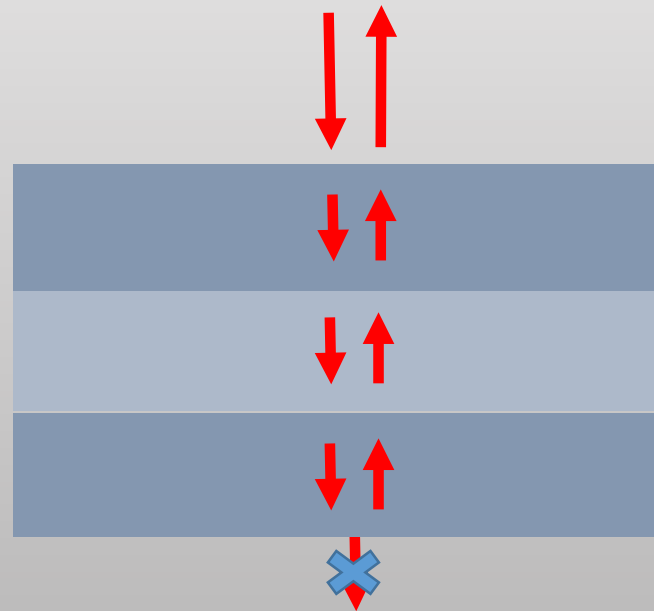

Nanostructured trampolines



Bjarke Jeppesen
(iNano)



TEM window
(Norcada, 30\$)

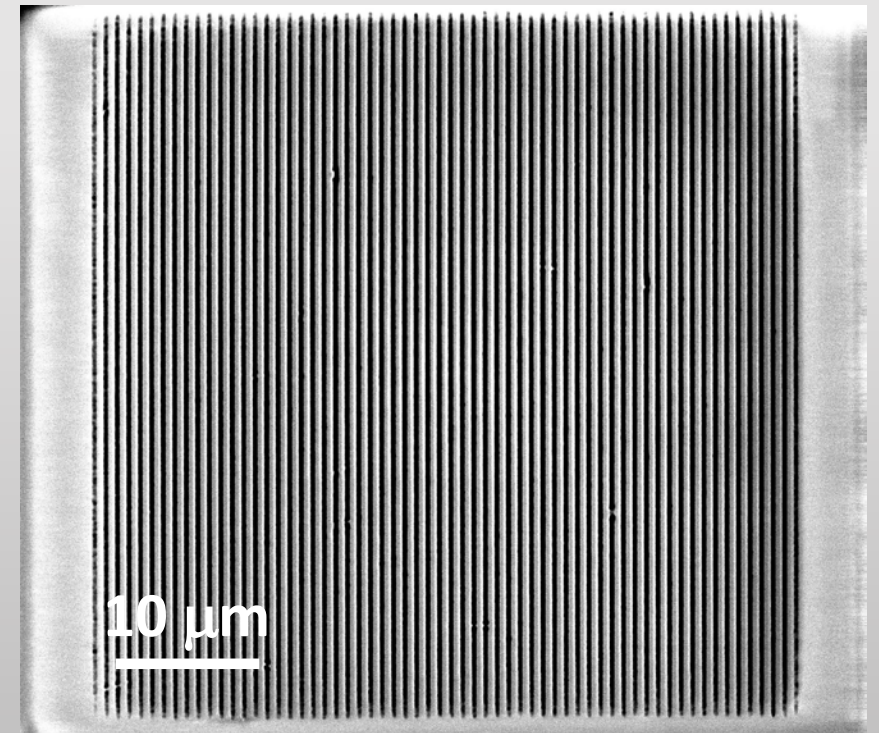
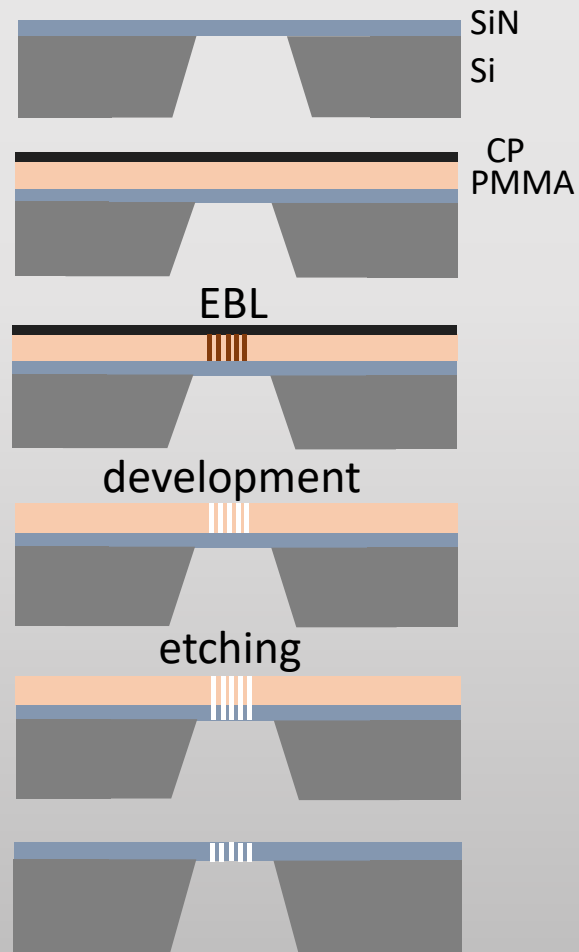
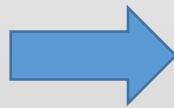

SEM picture

Nanostructured trampolines

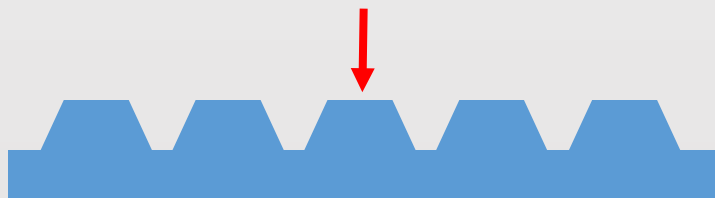

200×200 μm²

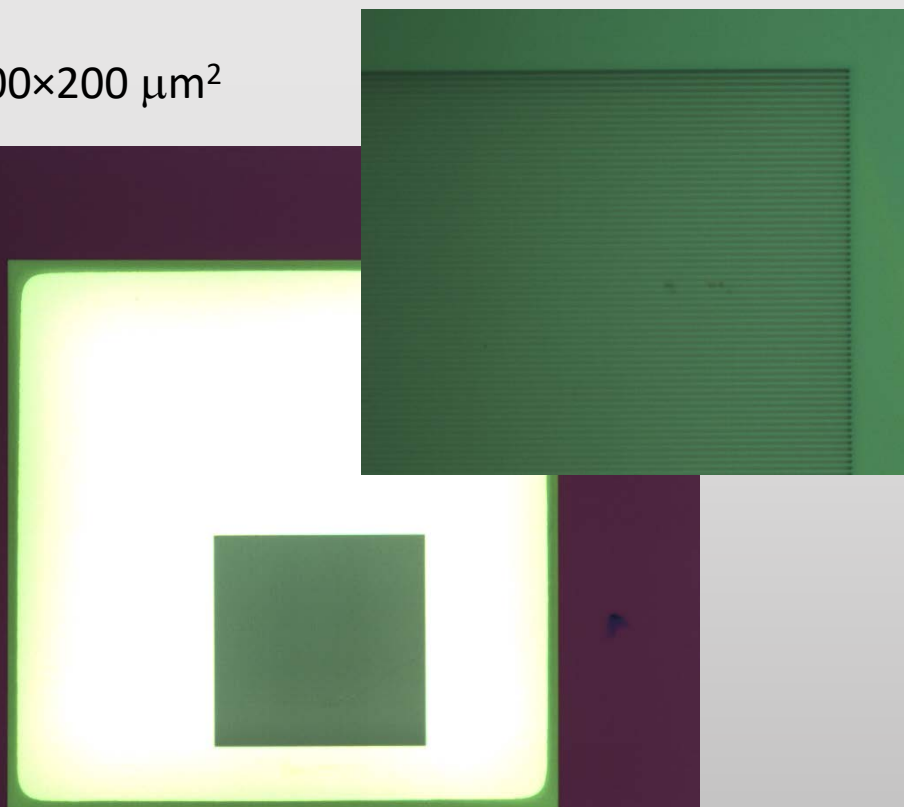

MSc project Alexios Parthenopoulos

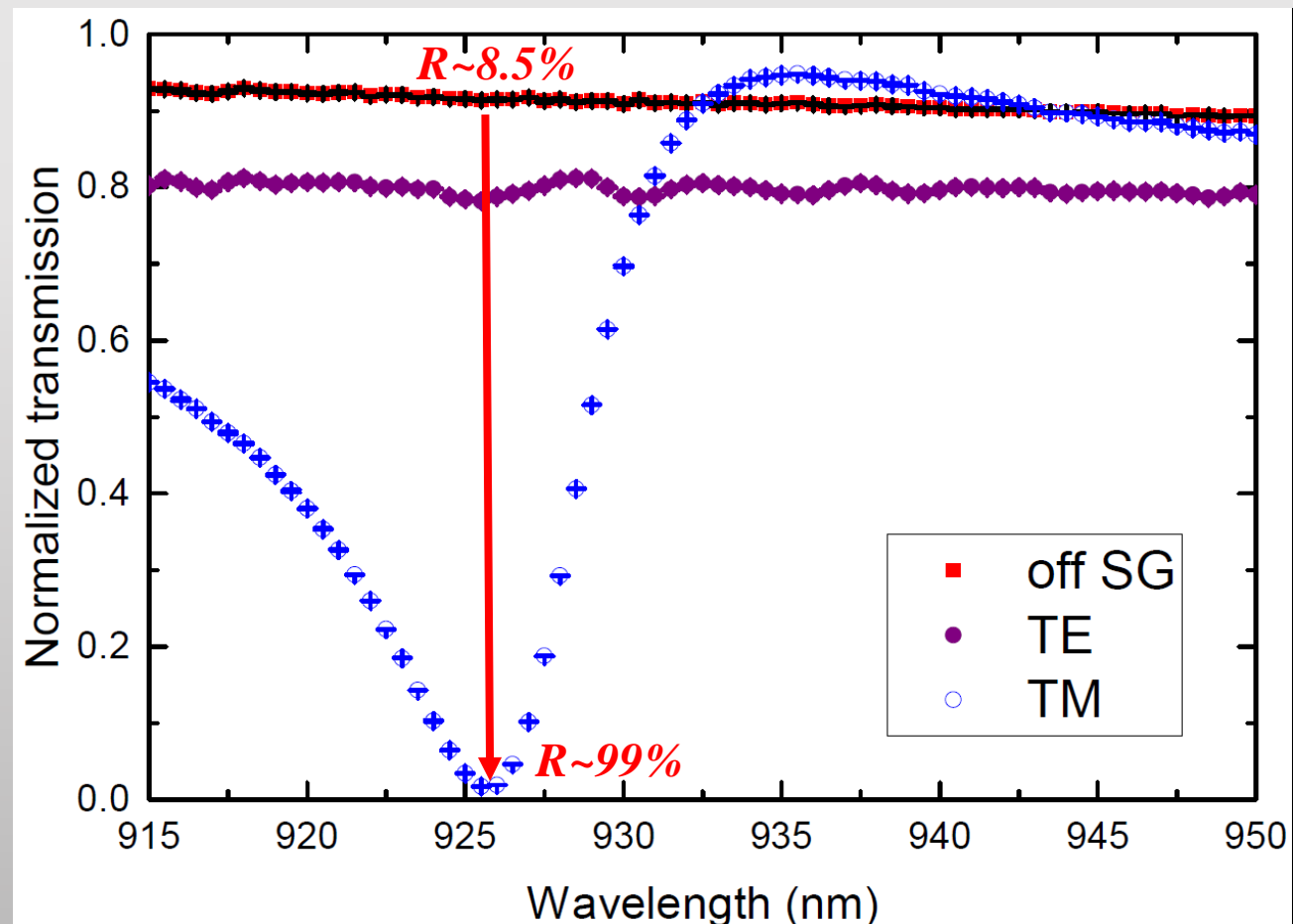

Nanostructured trampolines



Jens V. Nygaard (Eng.)

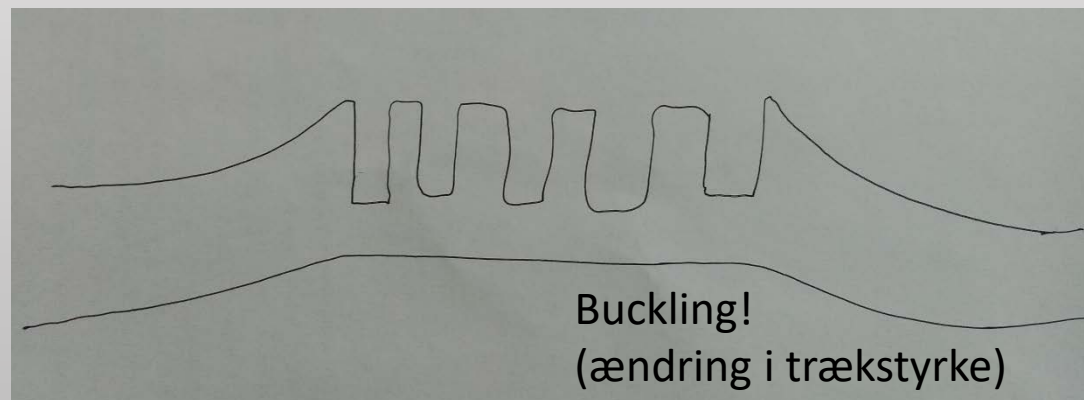
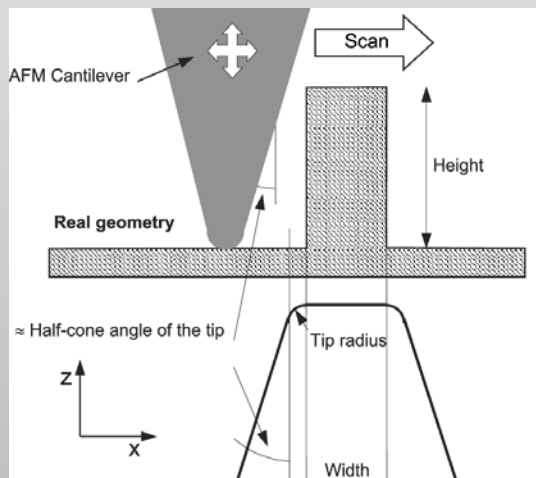
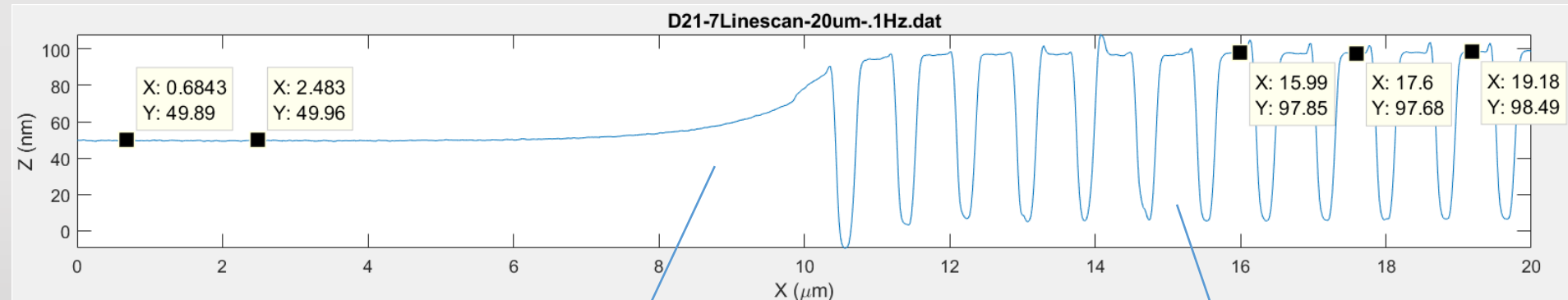
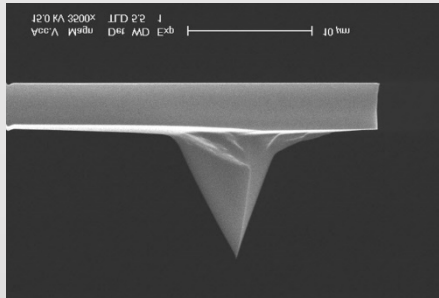

Gitterparametre



Optiske
simuleringer

Nanostructured trampolines

Master projects

Alexios Parthenopoulos, Christian Vandborg

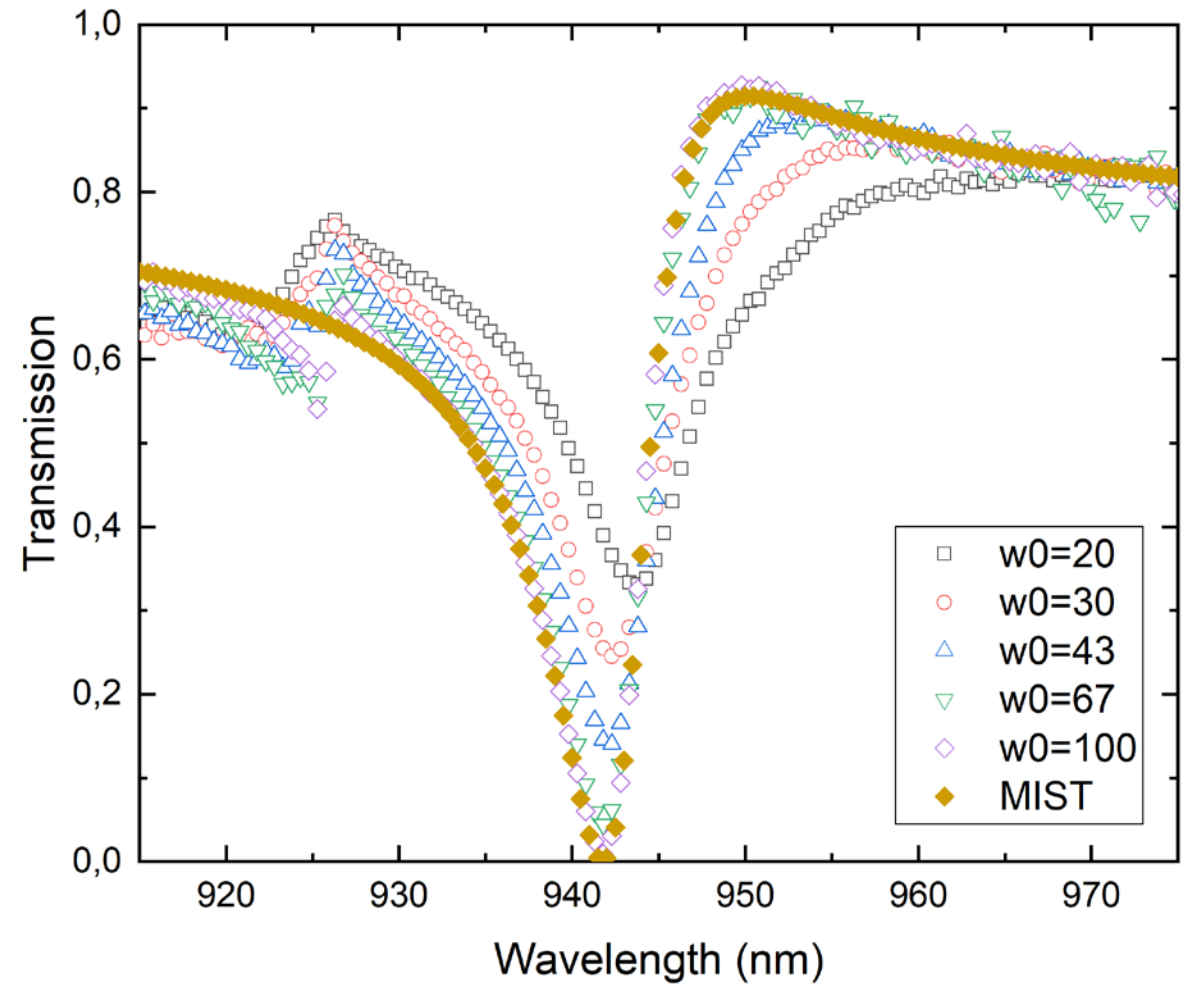
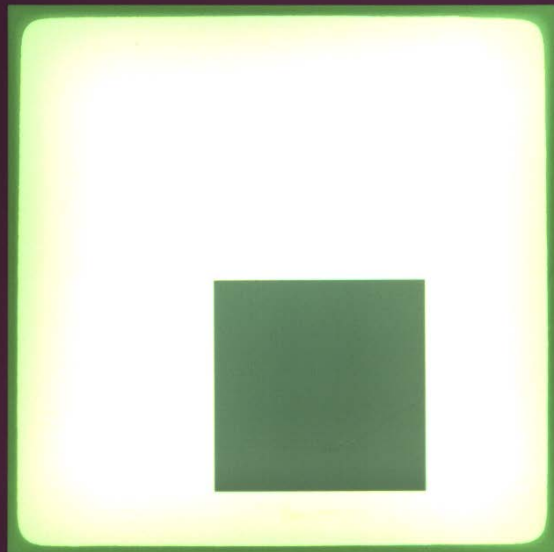
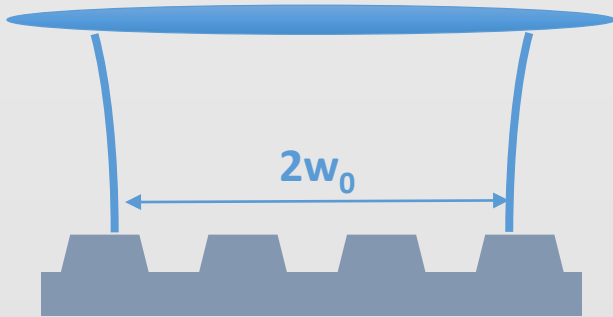

Optical spatial differentiator

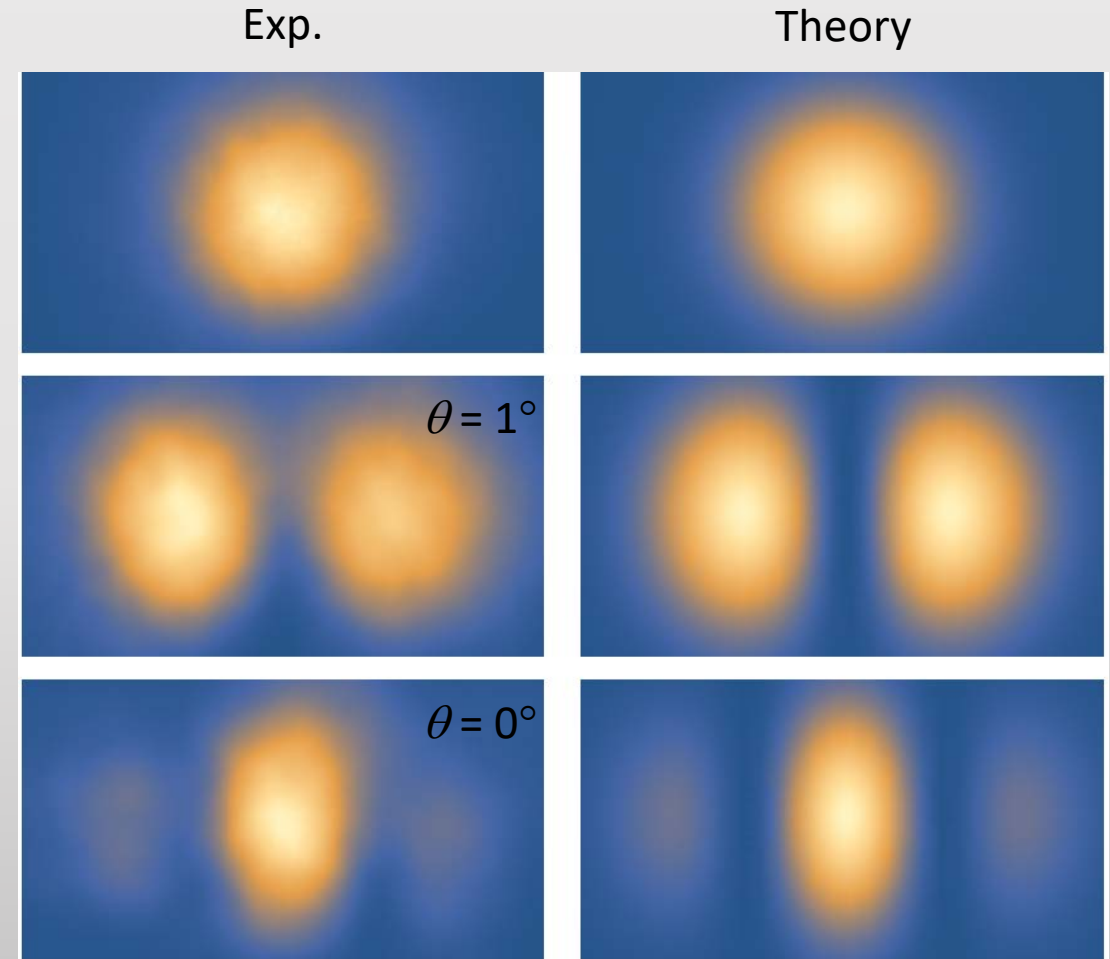
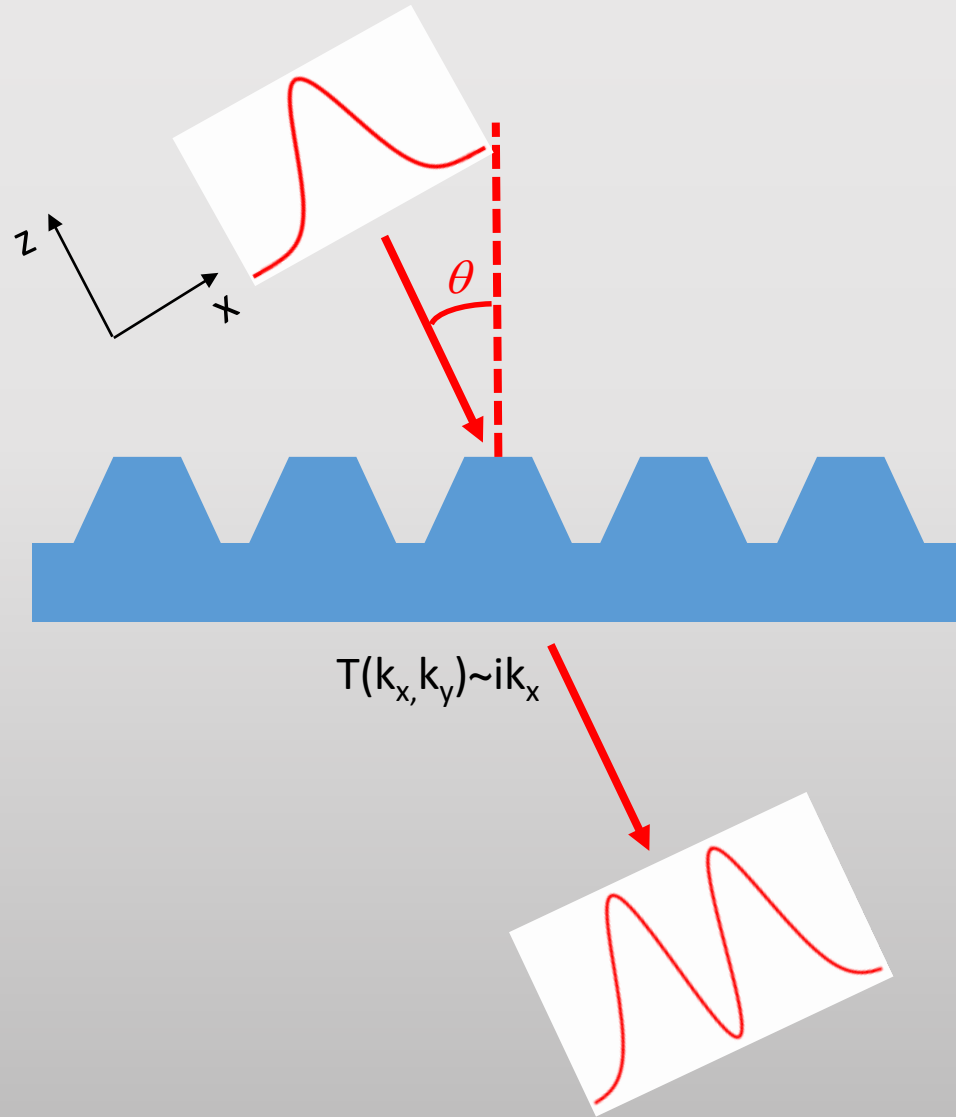

Bachelor/master projects

- Characterization nanostructured trampolines (optical and/or vibrational)
- Fabrication nanostructured trampolines (iNano) (spin coating, EBL, etching, SEM, AFM, ellipsometry...)
- Simulations (optical/mechanical) of nanostructured membranes
- Pressure sensor assembly & characterization
- Small building/automatisation projects (ASVAP)

